

SKINDICHT® SVF

SKINDICHT® SVF, PG flat cable gland with automatically fitting lateral sealing lips and high mechanical stability

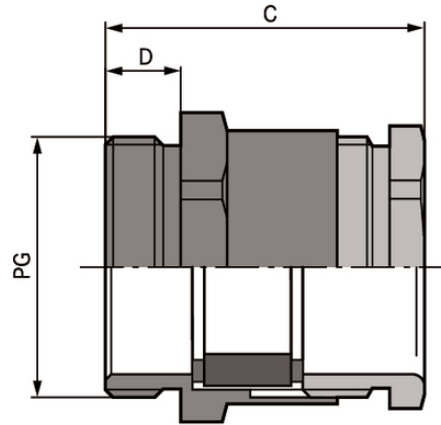

Wide clamping range



Assembly time



Optimum strain relief



Robust



Reliability

Benefits

High mechanical stability

Lateral sealing lips fit automatically around various cable dimensions

Optimum strain relief

Large opening allows clamping of up to two flat cables

Application range

For inserting flat cables

Conveyor systems

Pumps

Lifts

Control cabinet manufacturing

Product Make-up

PG connection thread

Last Update (27.03.2025)

©2025 Lapp Group - Technical changes reserved

Product Management www.lappkabel.de

You can find the current technical data in the corresponding data sheet.

PN 0456 / 02_03.16

SKINDICHT® SVF

Note

For suitable flat cables, refer to ÖLFLEX® LIFT F for indoor applications or ÖLFLEX® CRANE F for outdoor applications
Counter nut to be used: SKINDICHT® SM

Technical Data

Classification ETIM 5:	ETIM 5.0 Class-ID: EC000441 ETIM 5.0 Class-Description: Cable screw gland
Classification ETIM 6:	ETIM 6.0 Class-ID: EC000441 ETIM 6.0 Class-Description: Cable screw gland
Caution:	The installation dimensions can be found in appendix T21
On request:	Available with long connection thread
Material:	Body: nickel-plated brass Special sealing insert: CR
Protection rating:	IP 54
Temperature range:	-20°C to +100°C

Note

Photographs and graphics are not to scale and do not represent detailed images of the respective products.
Prices are net prices without VAT and surcharges. Sale to business customers only.

SKINDICHT® SVF

Article number	Article designation / size	Min./max. flat cable width	Cable thickness min. / max. mm	SW1/SW2 mm	Overall length C mm	Thread length D mm	Pieces / PU
SKINDICHT® SVF							
52005480	PG 16	-- 16.0	-- 5.0	24.0 / 22.0	27.5	6.5	25
52005490	PG 21	9.0 - 21.0	3.0 - 8.0	30.0 / 28.0	30.0	7	25
52005500	PG 29	14.0 - 30.0	4.0 - 11.5	40.0 / 37.0	31.5	8	10
52005510	PG36	24.0 - 40.0	4.0 - 11.5	50.0 / 47.0	36.0	9	10
52005520	PG 42	29.0 - 45.0	5.0 - 12.0	57.0 / 54.0	40.0	10	5
52005530	PG 48	34.0 - 50.0	5.0 - 12.0	64.0 / 60.0	41.5	10	5

Last Update (27.03.2025)

©2025 Lapp Group - Technical changes reserved

Product Management www.lappkabel.deYou can find the current technical data in the corresponding data sheet.
PN 0456 / 02_03_16