

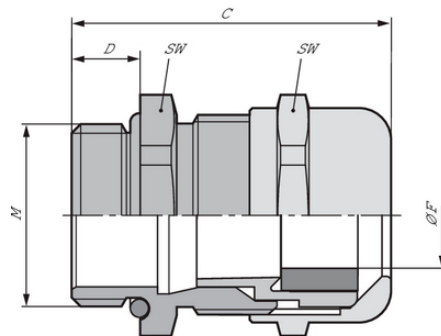







SKINTOP® MSR-M-XL

SKINTOP® MSR-M-XL, metric cable gland with variable clamping ranges and reducing seal insert, especially for thick walls

Info

With IP69 approval! Proven to withstand the most demanding cleaning procedures for industrial machinery with high-pressure cleaners and hot water!



-  Good chemical resistance
-  Corrosion-resistant
-  Mechanical resistance
-  Optimum strain relief
-  Acid-resistant
-  Temperature-resistant
-  Variety of approval certifications

Benefits

- Especially for thick walls
- Maximum reliability
- Optimum strain relief
- Wide, variable clamping ranges

Last Update (18.12.2024)

©2024 Lapp Group - Technical changes reserved

Product Management www.lappkabel.de

You can find the current technical data in the corresponding data sheet.

PN 0456 / 02_03.16

SKINTOP® MSR-M-XL

Application range

With reducing seal insert, to seal cables with smaller outer diameters

Norm references / Approvals

UL File Nr. E79903

Product Make-up

Metric connection thread acc. to DIN EN 60423

Basis for technical information DIN IEC 62444

Technical Data

Classification ETIM 5:	ETIM 5.0 Class-ID: EC000441 ETIM 5.0 Class-Description: Cable screw gland
Classification ETIM 6:	ETIM 6.0 Class-ID: EC000441 ETIM 6.0 Class-Description: Cable screw gland
Caution:	Refer to Appendix T21 for the installation dimensions and torques
Material:	Body: nickel-plated brass Insert: polyamide Sealing: CR O-ring: NBR
Protection rating:	IP 68 - 10 bar IP 69 NEMA Type 1, 4x, 6, 12
Temperature range:	Dynamic: -25 °C up to +100 °C Fixed: -40 °C to +100 °C

Note

Photographs and graphics are not to scale and do not represent detailed images of the respective products.
Prices are net prices without VAT and surcharges. Sale to business customers only.



SKINTOP® MSR-M-XL

Article number	Article designation / size	Ø F mm	SW wrench size mm	Overall length C mm	Thread length D mm	Pieces / PU
SKINTOP® MSR-M-XL						
53112105	M 12 x 1,5	2 - 5.0	16	32.0	12	100
53112115	M 16 x 1,5	2 - 7.0	20	38.0	12	50
53112125	M 20 x 1,5	5 - 10.0	24	41.0	12	50
53112135	M 25 x 1,5	6 - 13.0	29	42.5	12	25
53112145	M 32 x 1,5	7 - 15.0	36	51.5	15	25
53112155	M 40 x 1,5	15 - 23.0	45	54.5	15	10
53112165	M 50 x 1,5	22 - 29.0	54	60.5	15	5

Last Update (18.12.2024)

©2024 Lapp Group - Technical changes reserved

Product Management www.lappkabel.de

You can find the current technical data in the corresponding data sheet.

PN 0456 / 02_03_16