

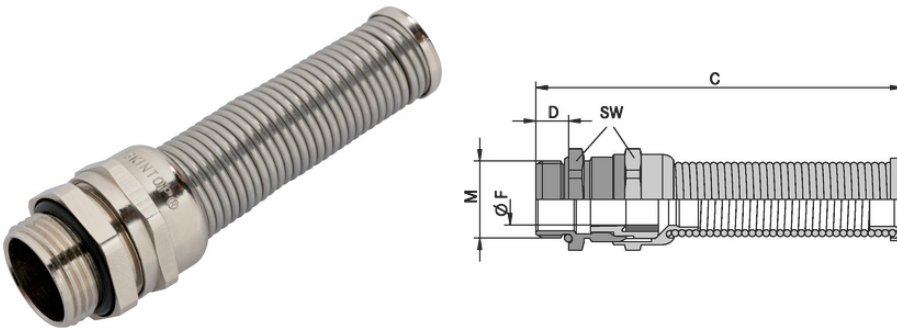







SKINTOP® BS-M METAL / SKINTOP® BSR-M METAL

Brass cable gland with bending protection spiral for use on moving machine parts.

Info

Permanent bending protection under high mechanical stress



-  Good chemical resistance
-  Wide clamping range
-  Optimum strain relief
-  Robust
-  Reliability
-  Voltage
-  Interference signals
-  Temperature-resistant

Benefits

Bending protection spiral prevents excessive bending as well as kinking of the connected cable.
 Special design of the stainless steel spiral allows high number of bending cycles.
 Large, variable clamping range for different cable outer diameters.
 Best possible sealing by O-ring and sealing ring enables protection class IP 68 (10 bar) and IP 69.

SKINTOP® BS-M METAL / SKINTOP® BSR-M METAL**Application range**

Especially on moving machine parts.
Withstands high mechanical loads.
Suitable for outdoor use.

Product Make-up

Metric connection thread acc. to DIN EN 60423
Basis for technical information DIN IEC 62444

Note

Variant "R" with reduction sealing insert for sealing smaller diameter pipes.

Technical Data

Classification ETIM 5:	ETIM 5.0 Class-ID: EC000441 ETIM 5.0 Class-Description: Cable screw gland
Classification ETIM 6:	ETIM 6.0 Class-ID: EC000441 ETIM 6.0 Class-Description: Cable screw gland
Caution:	Refer to Appendix T21 for the installation dimensions and torques
Material:	Body: nickel-plated brass Insert: polyamide Sealing: CR O-ring: NBR Spiral - springs made of stainless steel
Protection rating:	IP 68 - 10 bar IP 69
Temperature range:	Dynamic: -25 °C up to +100 °C Fixed: -30 °C up to +100 °C

Note

Photographs and graphics are not to scale and do not represent detailed images of the respective products.
Prices are net prices without VAT and surcharges. Sale to business customers only.

SKINTOP® BS-M METAL / SKINTOP® BSR-M METAL

Article number	Article designation / size	Ø F mm	Thread length D mm	SW wrench size mm	Overall length C mm	Pieces / PU
SKINTOP® BS-M METAL						
53806759	M 12 x 1,5	3.5 - 7.0	6.5	16	65.0	25
53806760	M 16 x 1,5	4.5 - 10.0	7	20	79.0	25
53806761	M 20 x 1,5	7 - 13.0	8	24	95.0	25
53806762	M 25 x 1,5	9 - 17.0	8	29	109.0	25
SKINTOP® BSR-M METAL						
53806769	M 12 x 1,5	2 - 5.0	6.5	16	65.0	25
53806770	M 16 x 1,5	2 - 7.0	7	20	79.0	25
53806771	M 20 x 1,5	5 - 10.0	8	24	95.0	25
53806772	M 25 x 1,5	6 - 13.0	8	29	109.0	25

Last Update (28.04.2024)

©2024 Lapp Group - Technical changes reserved

Product Management www.lappkabel.de

You can find the current technical data in the corresponding data sheet.

PN 0456 / 02_03_16