

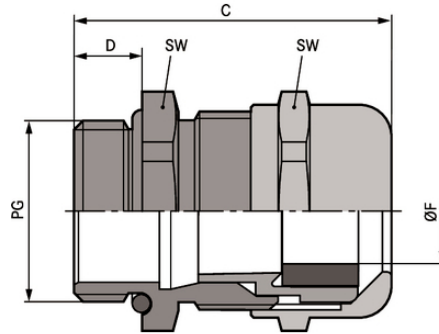





SKINTOP® MSR-XL

SKINTOP® MSR-XL, brass cable gland with reducing seal insert and long connection thread especially for thick walls



-  Good chemical resistance
-  Mechanical resistance
-  Optimum strain relief
-  Robust
-  Temperature-resistant
-  Variety of approval certifications

Benefits

- Especially for thick walls
- Maximum reliability
- Optimum strain relief
- Wide, variable clamping ranges

Application range

With reducing seal insert, to seal cables with smaller outer diameters

Product Make-up

PG connection thread acc. to DIN 40430

Technical Data

Last Update (23.04.2024)
 ©2024 Lapp Group - Technical changes reserved
 Product Management www.lappkabel.de
 You can find the current technical data in the corresponding data sheet.
 PN 0456 / 02_03.16

SKINTOP® MSR-XL

Classification ETIM 5:	ETIM 5.0 Class-ID: EC000441 ETIM 5.0 Class-Description: Cable screw gland
Classification ETIM 6:	ETIM 6.0 Class-ID: EC000441 ETIM 6.0 Class-Description: Cable screw gland
Caution:	Refer to Appendix T21 for the installation dimensions and torques
Material:	Body: nickel-plated brass Insert: polyamide Sealing: CR O-ring: NBR
Protection rating:	IP 68 - 5 bar
Temperature range:	Dynamic: -25°C up to +100°C Fixed: -40°C up to +100°C

Note

Photographs and graphics are not to scale and do not represent detailed images of the respective products.
Prices are net prices without VAT and surcharges. Sale to business customers only.

SKINTOP® MSR-XL

Article number	Article designation / size	Ø F mm	SW wrench size mm	Overall length C mm	Thread length D mm	Pieces / PU
SKINTOP® MSR-XL						
52115770	PG 7	2.0 - 5.0	14	32.0	12	100
52115780	PG 9	2.0 - 6.0	17	35.0	12	100
52115790	PG 11	3.0 - 7.0	20	38.0	12	50
52115800	PG 13,5	4.0 - 9.0	22	39.5	12	50
52115810	PG 16	6.0 - 13.0	24	40.5	12	50
52115820	PG 21	8.0 - 16.0	30	45.0	12	25
52115830	PG 29	10.5 - 20.0	40	52.0	15	25

Last Update (23.04.2024)

©2024 Lapp Group - Technical changes reserved

Product Management www.lappkabel.de

You can find the current technical data in the corresponding data sheet.

PN 0456 / 02_03_16