

EPIC® H-B 10 AD-LB

Housing design H-B. The industry standard.

The metal housing consists of a single lever and a seal and can be used, for example, in investment construction or lighting and sound systems.

Info

Single Lever version for quick locking and simple unlocking with lifting aid

Metal lid with sturdy hinge

Protection rating UL50E tested

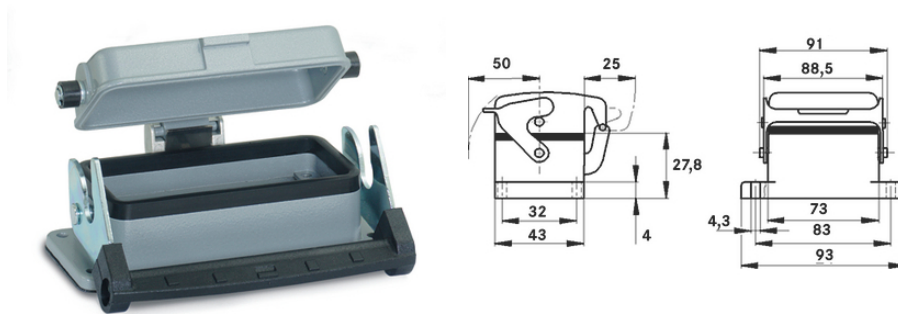

Supplementary automation components from Lapp



Mechanical and plant engineering



Mechanical resistance



Robust



Waterproof

Benefits

The smallest housing with single and double lever. The right housing is available for every application

Application range

Plant engineering

Light & sound technology

Plastics industry

Last Update (26.05.2023)

©2023 Lapp Group - Technical changes reserved

Product Management www.lappkabel.de

You can find the current technical data in the corresponding data sheet.

PN 0456 / 02_03.16

EPIC® H-B 10 AD-LB

Product features

H-A case: Wall base
Included: flat gasket
Standard and high version
Metal cover
Single lever

Technical Data

Classification ETIM 5:	ETIM 5.0 Class-ID: EC000437 ETIM 5.0 Class-Description: Housing for industrial connectors
Classification ETIM 6:	ETIM 6.0 Class-ID: EC000437 ETIM 6.0 Class-Description: Housing for industrial connectors
Material:	Housing: powder-coated aluminium alloy, grey Lever: zinc-plated steel Sealing: NBR
Protection rating:	IP 65 (latched) NEMA 250, UL50E: 12 (latched)
VDE-tested:	Certified production control: VDE-REG. no.: B437 UL-tested: UL File Number: E75770
Temperature range:	-40°C to +100°C, short-term up to +125°C

Note

Photographs and graphics are not to scale and do not represent detailed images of the respective products. Prices are net prices without VAT and surcharges. Sale to business customers only.

EPIC® H-B 10 AD-LB

Article number	Article description	M	Pieces / PU
H-B housing: panel-mount base (cover, single lever)			
10033900	H-B 10 AD-LB	AG	10

Last Update (26.05.2023)

©2023 Lapp Group - Technical changes reserved

Product Management www.lappkabel.de

You can find the current technical data in the corresponding data sheet.

PN 0456 / 02_03.16