

EPIC® H-B 16 SGRL-LB

Housing design H-B. The industry standard.

The metal housing for rectangular connectors consists of a single lever and a cable entry and is intended for investment construction.

Info

Single Lever version for quick locking and simple unlocking with lifting aid

For easy introduction of two cables

Protection rating UL50E tested

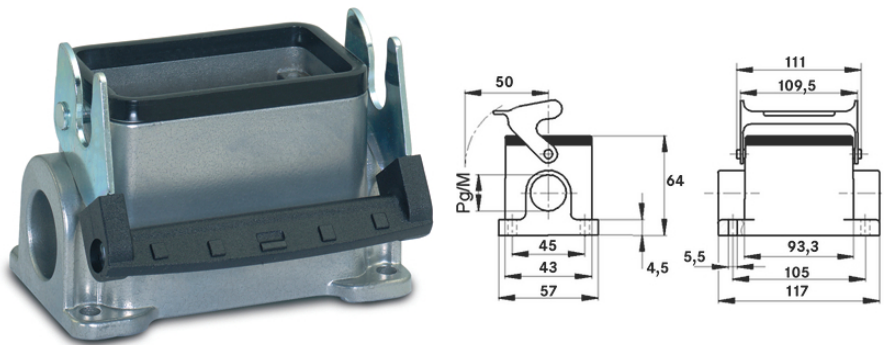

Supplementary automation components from Lapp



Mechanical and plant engineering



Mechanical resistance



Robust



Waterproof

Benefits

The housing standard. Wide choice for all applications

Application range

Plant engineering

Light & sound technology

Plastics industry

Last Update (21.01.2026)

©2026 Lapp Group - Technical changes reserved

Product Management www.lappkabel.de

You can find the current technical data in the corresponding data sheet.

PN 0456 / 02_03.16

EPIC® H-B 16 SGRL-LB

Product features

Surface-mount base, low version
Single lever
2 cable entries

Technical Data

Classification ETIM 5:	ETIM 5.0 Class-ID: EC000437 ETIM 5.0 Class-Description: Housing for industrial connectors
Classification ETIM 6:	ETIM 6.0 Class-ID: EC000437 ETIM 6.0 Class-Description: Housing for industrial connectors
Material:	Housing: powder-coated aluminium alloy, grey Lever: zinc-plated steel Sealing: NBR
Protection rating:	IP 65 (latched) UL50 Type 12 (latched)
VDE-tested:	Certified production control: VDE-REG. no.: B437 UL-tested: UL File Number: E75770
Temperature range:	-40°C to +100°C, short-term up to +125°C

Note

Photographs and graphics are not to scale and do not represent detailed images of the respective products.
Prices are net prices without VAT and surcharges. Sale to business customers only.



EPIC® H-B 16 SGRL-LB

Article number	Article description	M	Packaging unit
19075900	H-B 16 SGRL-LB M25	25	5

Last Update (21.01.2026)

©2026 Lapp Group - Technical changes reserved

Product Management www.lappkabel.de

You can find the current technical data in the corresponding data sheet.

PN 0456 / 02_03.16