

SILVYN® SSV-M

SILVYN® SSV-M - nickel-plated brass metric threaded conduit fitting

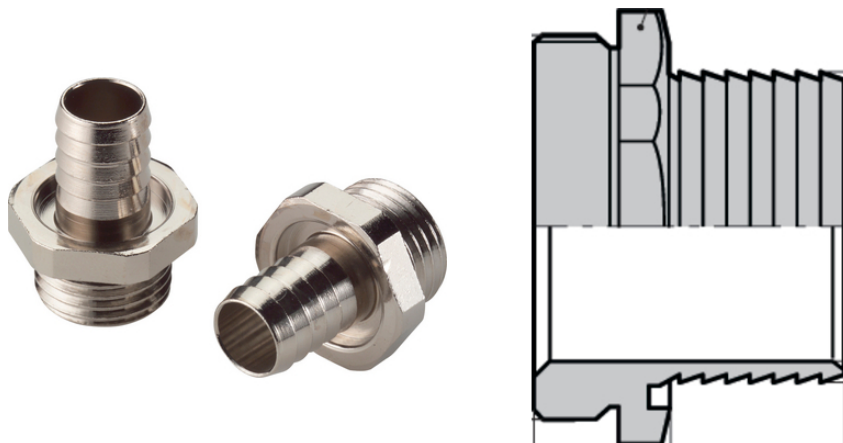

Optimum strain relief



Robust

Benefits

Conduit gland with high tensile strength for plastic conduits

Application range

In combination with protective conduit:

SILVYN® SI

SILVYN® SP

SILVYN® SP-PU

Product features

High-tensile

Robust

Compact design

Product Make-up

Metric connection thread

Conduit entry with special grip profile

Note

Necessary conduit clamp SILVYN® SCH

PG threaded versions are to be found in the online catalogue

Technical Data

Last Update (10.12.2022)

©2022 Lapp Group - Technical changes reserved

Product Management www.lappkabel.de

You can find the current technical data in the corresponding data sheet.

PN 0456 / 02_03.16

SILVYN® SSV-M

Classification ETIM 5:	ETIM 5.0 Class-ID: EC001180 ETIM 5.0 Class-Description: Screw connection for protective metallic hose
Classification ETIM 6:	ETIM 6.0 Class-ID: EC001180 ETIM 6.0 Class-Description: Screw connection for protective metallic hose
Material:	Body: nickel-plated brass O-ring: NBR
Temperature range:	-20°C to +80°C

Note

Photographs and graphics are not to scale and do not represent detailed images of the respective products. Prices are net prices without VAT and surcharges. Sale to business customers only.

SILVYN® SSV-M

Article number	Metric size	SW wrench size mm	Overall length mm	Thread length mm	Clear opening (mm)	Suitable for SILVYN® SCH	Suitable for SILVYN® SI	Suitable for SILVYN® SP	Suitable for SILVYN® SP-PU	Pieces / PU
SILVYN® SSV-M										
52002827	12 x 1.5/1	16	25	8	7	10 - 16 S	7 x 9	-	-	50
52002828	12 x 1.5/2	19	25	8	9	10 - 16 S	9 x 12	-	-	50
52002840	16 x 1.5/1	19	25	8	8	10 - 16 S	11 x 14	10 x 14	10 x 14	50
52002839	16 x 1.5/2	19	25	8	10	12 - 20 S	13 x 16	12 x 16	12 x 16	50
52002841	20 x 1.5/1	22	25	8	12	16 - 25 S	14 x 18	-	-	50
52002842	20 x 1.5/3	25	25	8	15.5	20 - 32 S	18 x 22	-	-	50
52002843	25x1.5	32	29.5	8.5	19	20 - 32 S	23 x 28	22 x 27	22 x 27	25
52002844	32 x 1.5	40	32.5	9.5	27	25 - 40 S	32 x 38	30 x 36	30 x 36	25
52002845	40x1.5	50	36	11	34	35 - 50 S	-	38 x 44	38 x 44	10
52002846	50 x 1.5	57	39	12	41	40 - 60 S	-	45 x 51	-	5
52002847	63 x 1.5	67	43	12	46	40 - 60 S	-	49 x 56	-	5

Last Update (10.12.2022)

©2022 Lapp Group - Technical changes reserved

 Product Management www.lappkabel.de

 You can find the current technical data in the corresponding data sheet.
 PN 0456 / 02_03_16