

## SILVYN® SSV

SILVYN® SSV - nickel-plated brass PG threaded conduit fitting

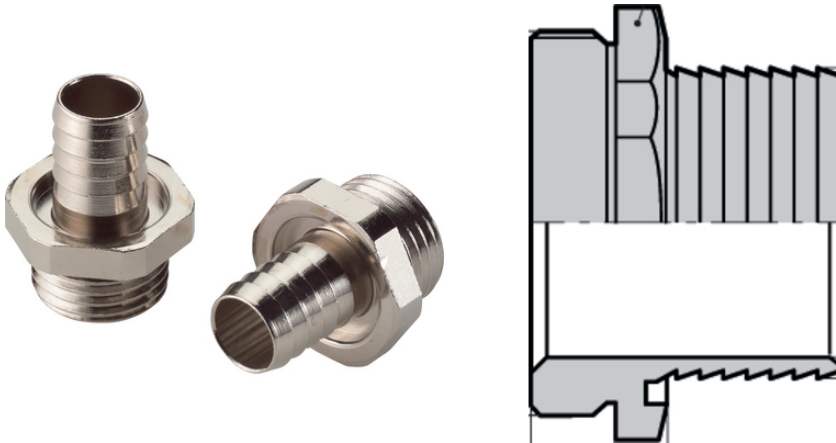

Optimum strain relief



Robust

### Benefits

Conduit gland with high tensile strength for plastic conduits

### Application range

In combination with protective conduit:

SILVYN® SI

SILVYN® SP

SILVYN® SP-PU

### Product features

High-tensile

Robust

Compact design

### Product Make-up

PG connection thread

Conduit entry with special grip profile

### Note

Necessary conduit clamp SILVYN® SCH

### Technical Data

Classification ETIM 5:

ETIM 5.0 Class-ID: EC001180

ETIM 5.0 Class-Description: Screw connection for protective metallic hose

Classification ETIM 6:

ETIM 6.0 Class-ID: EC001180

ETIM 6.0 Class-Description: Screw connection for protective metallic hose

Last Update (11.12.2022)

©2022 Lapp Group - Technical changes reserved

Product Management [www.lappkabel.de](http://www.lappkabel.de)

You can find the current technical data in the corresponding data sheet.

PN 0456 / 02\_03.16

**SILVYN® SSV**

Material:	Body: nickel-plated brass O-ring: NBR
Temperature range:	-20°C to +80°C

**Note**

Photographs and graphics are not to scale and do not represent detailed images of the respective products.  
Prices are net prices without VAT and surcharges. Sale to business customers only.

**SILVYN® SSV**

Article number	PG size	SW wrench size mm	Overall length mm	Thread length mm	Clear opening (mm)	Suitable for SILVYN® SCH	Suitable for SILVYN® SI	Suitable for SILVYN® SP	Suitable for SILVYN® SP-PU	Pieces / PU
SILVYN® SSV										
52003070	9	19	25	5.5	8	10 - 16 S	-	10 x 14	10 x 14	100
53800020	9	19	25	5.5	10	12 - 20 S	-	12 x 16	12 x 16	100
52003080	11	22	25	6	12	16 - 25 S	-	14 x 18	14 x 18	50
52024560	11	22	25	6	14	16 - 25 S	-	16 x 20	16 x 20	50
52003090	13.5	25	27.5	6.5	15.5	20 - 32 S	18 x 22	-	-	50
52003100	16	30	27.5	7.5	19	20 - 32 S	-	22 x 27	22 x 27	25
52003110	21	32	30	8	21	20 - 32 S	23 x 28	-	-	25
53800080	29	40	33	9.5	27	25 - 40 S	-	30 x 36	30 x 36	25
52024640	29	42	33	9.5	30	35 - 50 S	32 x 38	-	-	25
52002980	36	52	37	12	34	35 - 50 S	-	38 x 44	38 x 44	10
52002990	42	57	41	14	41	40 - 60 S	-	45 x 51	-	5

Last Update (11.12.2022)

©2022 Lapp Group - Technical changes reserved

 Product Management [www.lappkabel.de](http://www.lappkabel.de)

 You can find the current technical data in the corresponding data sheet.  
 PN 0456 / 02\_03\_16